

 **DISC MAKERS™**
ReflexAuto3



100 Disc Capacity
User's Manual
V2.0

Copyright and Trademark Information

The product and material in this manual is subject to change without prior notice and does not represent a commitment on the part of the vendor, who assumes no liability or responsibility for any errors that may appear in this manual.

All brand names and trademarks are properties of their respective owners. This manual contains materials protected under International Copyright Laws. All rights reserved. No part of this manual may be reproduced, transmitted or transcribed without the expressed written permission of Disc Makers Inc. The ReflexAuto is to be used in a lawful manner. Violation of the International Copyright Laws is a criminal charge. Disc Makers Inc. is not responsible for the illegal actions of users, nor consequential damage in connection with the furnishing, performance, or use of the equipment described herein.

Revision 2.00 12/14/05

Table of Contents

Title	Page
Chapter 1: Overview	1
1. Welcome	1
2. The Robotic platform	4
3. The LCD Control Panel	5
4. Menu Overview	6
5. Introduction to Manage Accounts	10
6. Single Master and Multi Master Modes	10
7. Setting Counters and Assigning Names	12
7.1. Setting Counters	12
7.2. Editing Names	13
Chapter 2: Operation	14
1. Copy	14
1.1. Making Copies in Single Master Mode	14
1.2. Making Copies in Multi Master Mode	16
2. Test	18
3. Compare	19
4. Test+Copy	20
5. Copy+Compare	20
6. Select Burn Speed	21
7. Select Source	22
8. Master Mode	22
9. Erase RW	22
10. Hard Drive Setup	24
10.1. Select Partition	24
10.2. Load Partition	25
10.3. Rename Partition	25
10.4. Delete Partition	26
10.5. Partition Info	26
10.6. Partition Size	26
10.7. Format Hard Drive	27

Title	Page
11. Setup	27
11.1. Language	28
11.2. Read Error Skip	28
11.3. CD Writing Mode	28
11.4. Max Audio, VCD & CDG Speed	29
11.5. Buzzer	29
11.6. Startup Menu	29
11.7. Screen Saver	30
11.8. Counter	30
11.9. AUTOCOPY Enabled	30
11.10. DVD+R High Compatibility Mode	32
11.11. Disable Drives	32
12. System Utilities	33
12.1. Disc Info	33
12.2. System Info	34
12.3. Device Info	35
12.4. Load Default	35
12.5. Update Firmware	35
13. Loader Utilities	36
13.1. Drive Alignment	36
13.2. Spindle Alignment	37
13.3. Disc Separator	38
13.4. Z form Maneuver	38
13.5. Alignment Protection	38
14. Manage Accounts	39
14.1. View User	39
14.2. Create User	40
14.3. Edit User Info	40
14.4. Delete User	41
14.5. Password on Bootup	41
15. Shutdown	41
Chapter 3: Trouble Shooting	42
Chapter 4: List of Error Codes	43
Chapter 5: Menu Tree	45

Chapter 1: Overview

1. Welcome

The Disc Makers ReflexAuto autoloader is a reliable, high performance, high speed, standalone, robotic DVD and/or CD autoloader. With its professional industrial design and simple user interface, it makes your duplicating experience easier than ever.

With the Disc Makers ReflexAuto, you can have a capacity up to 100 discs, duplicate continuously for 24 hours (even with multiple masters), and get the highest quality duplication, all at an extremely affordable price. The Disc Makers ReflexAuto is the most reliable and affordable autoloader on the market.

Before you start using this autoloader, please read the following to ensure proper operation:

DVD Duplication Limitations

The DVD autoloader will not copy any DVDs that have Copy Protection encoded in the content. Typically, most DVDs you purchase or rent from a store contains Copy Protection. In addition to the copy protection limitation, the autoloader will only copy a DVD5 format (4.7 GB) disc to another DVD5 format recordable DVD media. If your autoloader has double layer/dual layer capability, you can copy a DVD9 format (8.5 GB) disc to another DVD9 format recordable DVD media, but you cannot duplicate a DVD5 format disc on to a DVD9 format recordable media or vice versa.

Temperature Warning

If the autoloader was stored in a location where the temperature dropped below 32° F (0° C) within the past 24 hours, leave the autoloader in a warm room with temperatures at least 65° F (19° C) for four hours prior to powering it on for the first time. Failure to do so may cause irreparable harm and prevent the autoloader from functioning.

Maintenance

It is very important to operate and keep the autoloader in a dust free, clean environment since dust is the number one killer of CD/DVD recording devices. Failure to do so can severely damage your autoloader. We strongly suggest that you constantly use an Air Duster (Canned Air) to clear off any dust on the surface of the autoloader.

Note: Do not try to use an Air Duster to clean the autoloader while the writer trays are open. In doing so, you may inadvertently blow dust into the recording device and damage it.

Proper Shutdown

To avoid possible system failures, you need to shut down the autoloader properly. To shut down the autoloader use the **Shutdown** hot key and follow the instructions on the screen. Not performing this function increases the risk of damaging the autoloader.

Double Layer/Dual Layer Partition Issue

If you have a 16x speed or higher autoloader with double layer/dual layer DVD9 capability, the hard drive partitions are set to a default size of 9 GB each to accommodate for the expanded size of the DVD9 format. If you require more partitions and do not plan on using double layer/dual layer DVD9 media, you can reduce the size of the partitions using the instructions given in "Partition Size" on page 26. Keep in mind that if you alter the partition size, all previous data/video stored on the hard drive will be lost and you will only be able to load media with less than 5 GB capacity such as DVD5 (4.7 GB), CD (700 MB), etc.

Disc Static and Sticky Media Issues

The most common problems when using an autoloader are the disc static and sticky media issues. These static charge problems cause multiple discs to stick together, resulting in improper operation and more severely, can shocks the robotic arm while loading a disc that causes system freeze due to heavy static charge. Even though the autoloader has a sticky media separator function to prevent the sticky media, but you should still follow these steps to prevent sticky media from disrupting your operation and protect your system from disc static charge.

This issue is most commonly seen when you buy a 100 pack of blank discs and insert them into the autoloader without any treatment. If you have experienced this kind of problem, please do the following to remove the adhesive static between the discs:

- Separate the blank discs before you place them into the autoloader's spindle(s). Separating them will greatly reduce the static between discs.
- If this doesn't achieve the desired outcome, use an air duster (canned air) to blow air around the circular edge of the blank discs. This process reduces the static between the discs up to 90%. The amount of air to use depends on factors specific to your environment.



Figure 1-1 Using Canned Air to Reduce Static

- If you are still having problems, put your media into the refrigerator (NOT in the freezer) for three hours. Afterwards, store it at room temperature for one hour prior to use. Studies show that cold temperature (with no condensation) will also reduce the static charges between objects dramatically.

Disc Placement Issue

Another common problem when using an autoloader is the placement of media onto the spindles. Placing the media onto the spindles properly can avoid possible picking errors when operating the autoloader. Even though the autoloader is designed with certain tolerance adjustments to prevent mishandling by the picking arm, failures may still arise if the spindles are not loaded correctly. All media loaded onto the spindles should be flat and not slanted at an angle to ensure the picking arm can securely grab the disc with all 3 vacuum suction heads. Be sure to not load too many discs onto the spindle as well as this may cause errors in placement and loading. The diagram 1-2 below demonstrates the proper and incorrect disc placements when loading media onto the spindles.

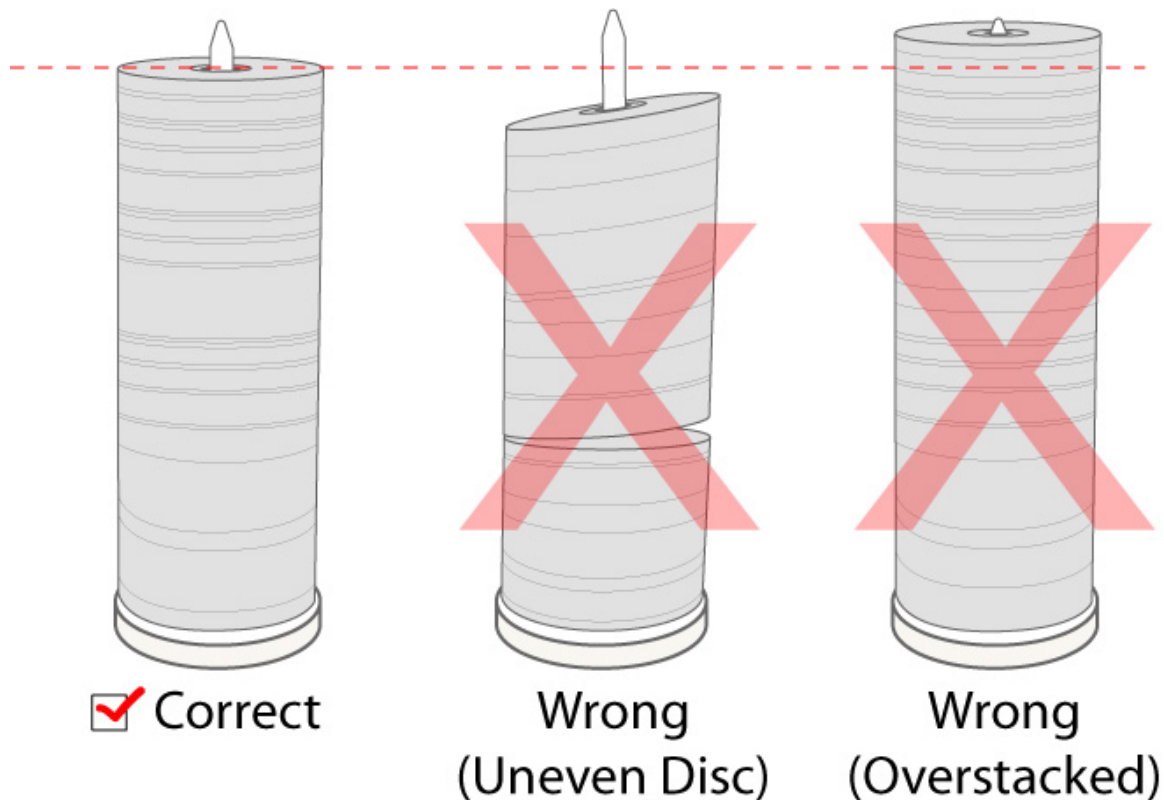

Figure 1-2 Disc Placement Illustration

Spindles vs. Bins

The Disc Makers ReflexAuto has up to 2 spindles for holding CDs and/or DVD's. Although the manual refers to them as spindles, many of the messages shown on the LCD display refer to them as bins in order to create more concise messages. Don't panic. Spindles and bins are the same.

2. The Robotic Platform

The Disc Makers ReflexAuto autoloader with (100 Disc Capacity) has two spindles (see Figure 1-3) that hold approximately 100 discs each, (Actual quantity varies depends on the media thickness). Spindle 2 is the input spindles. Spindle 1 is the output spindle. Stack the media you wish to copy on spindle 2 (see figure 1-2 from proper media stacking). The robotic arm will pick discs from spindle 2 then place the successfully copied discs onto spindle 1. Reject discs are placed on to the deck below the drive trays. (Throughout this manual, this area is also referred as “Reject Area”).

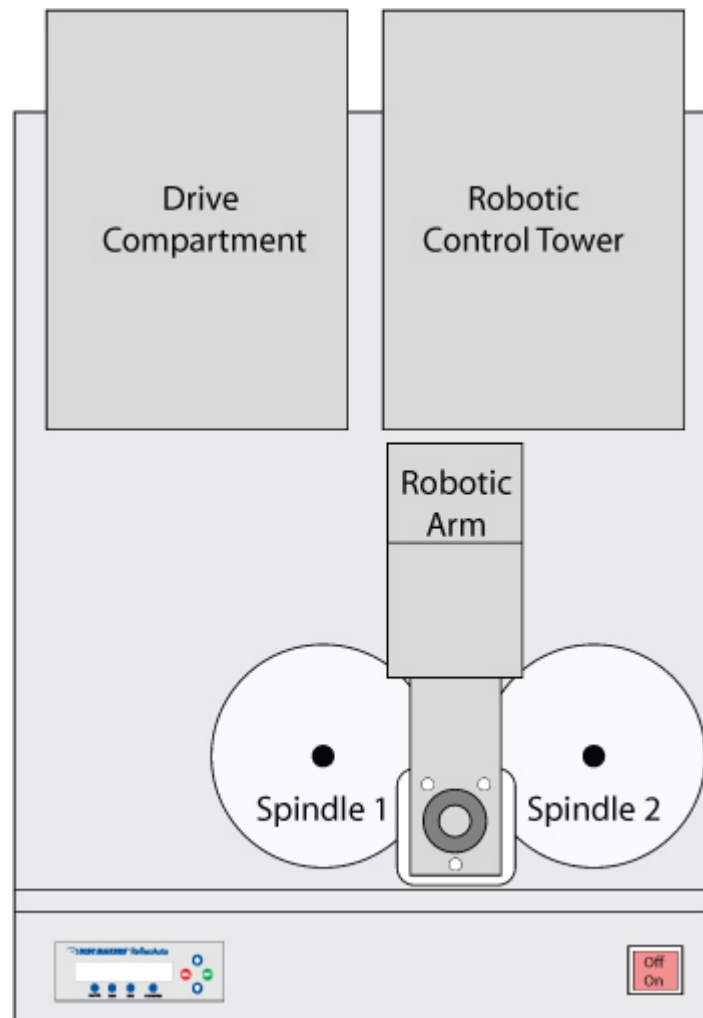

Figure 1-3 Robotic Duplicator Top View





3. The LCD Control Panel

Figure 1-4 below shows the LCD Control Panel. This panel has a two-line by 20 character LCD display to provide user feedback and eight push buttons to control the of the Disc Makers ReflexAuto operation. The functions for these buttons are shown in Table 1-1.



Figure 1-4 LCD Control Panel Layout

Table 1-1: Front Panel Controls

Control	Name	Function
	Up	Scroll up through the menu or list.
	Down	Scroll down through the menu or list.
	Enter	Execute the function. Also called OK in the Menus.
	ESC	Go back to the previous function.
Master	Master	Quick Key to put machine in the correct Master Mode.
Load	Load	Quick key to load a master disc to the units internal hard drive
Info	Info	Quick key to see system, master disc, and hard drive image information including partition size, disc size, disc type, drive and system firmware versions.
Shutdown	Shutdown	Quick key to properly turn off the unit.

4. Menu Overview

This section provides an overview of the menu options. These menu options are explained in detail on the referenced pages.

1. Copy page 14

Use the *Copy* menu to make copies of a master disc or hard drive image. Before you start a copy, make sure you have selected the correct Master Mode.

If you plan to use Single Master Mode, please make sure you have successfully loaded your master disc to a partition on the Hard Drive.

If you plan to use Multi Master Mode, please make sure you have placed every master disc on top of the corresponding number of blank discs.

For additional information, see “Making Copies in Single Master Mode” on page 14 or “Making Copies in Multi Master Mode” on page 16.

2. Test page 18

Use the *Test* menu to simulate the copy process. With simulation, write once recordable discs such as DVD-R, or CDR will be reusable. The purpose of simulation is to ensure error free duplication.

Note: *Due to physical limitations of the DVD+R recordable format, you can not test or simulate the DVD+R copy format.*

Warning: *If you are using CD/DVD Rewritable discs as your blank media during the simulation, the content on those discs will be permanently erased.*

3. Compare page 19

Use the Compare function to perform a bit-by-bit comparison between the content of your master disc(s) in the Hard Drive and the contents of all discs it copied. This ensures that all of your copies are identical to original master disc(s).

Note: *The bit-by-bit comparison will only apply on all DVDs and Data CDs. The readability check will be applied for other formats like Audio CDs, CD+G, and Video CDs discs due to their lack of error correction mechanisms.*

4. Test + Copy page 20

Use the *Test + Copy* menu option to simulate the copying process initially. Then, the autoloader performs the actual copy process on the blank disc(s) that passed the simulation. For the blank disc(s) that didn't pass the simulation, the autoloader will place it/them to the Reject Area.

5. Copy + Compare page 20

Use the *Copy + Compare* menu option to make 100% reliable copies. After the copy process is done, the autoloader automatically compares the copies from the content of your original master disc.

6. Select Burn Speed page 21

Use the *Select Burn Speed* menu option to adjust the duplication speed for the various blank disc formats. For additional information, see “Select Burn Speed” on page 21.

7. Select Source page 22

Use the *Select Source* menu to tell the system where the content of the master disc resides during duplication. At this point, Hard Drive is the only place where the content of the master disc resides during duplication. For additional information, see “Select Source” on page 22.

8. Master Mode page 22

Use the Master Mode menu to select either Single Master Mode(SM) or Multi Master Mode (MM). For more information on those modes, see “Single Master and Multi Master Modes” on page 10. For more information on using the Master Mode menu, see “Master Mode” on page 22

9. Erase RW page 22

Use the Erase RW menu to erase your Rewritable discs. There are two options:

- **Full Erase:** This option erases the entire disc, destroying all previously written data in the process.
- **Quick Erase:** This option erases the index (TOC) of the Rewritable disc, not the data section. It is much faster than Full Erase. However, the data section is still recoverable. If you prefer the old content not to be recovered for security purpose, please perform Full Erase.

10. Hard Drive Setup page 24

Use the Hard Drive Setup menu to perform various hard drive-related operations. These options include loading, renaming, or deleting your images. For additional information, see “Hard Drive Setup” on page 24.

11. Setup page 27

Use the Setup menu options to control how the autoloader operates. You can scroll between the various options using the **Up or Down** button.

1. Language

Use this setting to choose the language used to navigate the autoloader. The autoloader supports English and Spanish menus.

2. Read Error Skip

Normally, when the autoloader encounters a read error while reading the master disc, all the duplication will be aborted and all the recordable media in the writers will be ruined. However, if you believe that your master disc has a small, insignificant error due to physical damage, you can enable this setting to allow the autoloader to skip any read errors that it encounters. It is ON by default.

***Important:** This function does not fix the error; it only skips it to continue copying the rest of the readable data. This function is recommended for Video and Audio duplication purpose.*

3. CD Writing Mode

Use this setting to select the mode you would like use to duplicate a CD. There are two different modes: Disc at Once and Track at Once. Disc at Once is recommended for duplication.

4. Max Audio, VCD & CDG Speed

Due to the lack of error checking mechanism for Audio CD, Video CD and CD+G format, duplicating them at too high a speed can cause frequent errors like glitches and skips. Use this setting to adjust the maximum duplication speed for Audio, Video CD and CD+G format to ensure the reliable duplication for such formats.

5. Buzzer

Use this setting to choose whether you want to hear a beep when you press a button and when a task has been completed.

6. Startup Menu

Use this setting to choose which menu you would like to see first when you turn on the autoloader.

7. Screen Saver

Use this setting to enable or disable the *Screen Saver* feature. When this is enabled, a screen saver is displayed whenever your autoloader has been idle for a long period of time.

8. Counter

Use the Counter menu to enable or disable the *Counter* feature. The counter tells you how many discs have been copied and how many discs are left to go during the progress and it will stop the job once the desired number of copies has been made.

9. AUTOCOPY Enabled

This menu option turns on the hidden *16.AUTOCOPY* main menu option. The *AUTOCOPY* function simplifies the copy process by allowing you to stack blank media on a spindle(s), place the master on top of the stack on the first spindle, and press the **Enter** button on *16.AUTOCOPY* key in the main menu. It will load the content of the top disc of the 1st input spindle (master disc) into the Reserved Partition of the Hard Drive and copy it to blank disc(s) below it and other input spindle(s) if exists.

10. DVD+R Compatibility Mode

This feature allows you to turn the *DVD+R High Compatibility Mode* feature ON or OFF. The purpose of this feature is to increase the compatibility of DVD+R media with a broader range of DVD Video players.

11. Disable Drives

Use this utility to allow the system to disable certain drives/trays when certain drives/trays are producing high failure rates. See "Disable Drives" on page 32.

12. System Utilities

page 33

1. Disc Info

Use the Disc Info utility to identify the type of blank recordable media. This utility identifies your blank recordable Media's format, capacity, manufacture ID, and the Media's certified writing speed.

2. System Info

Use this menu option to see data about the autoloader and its resources (firmware version, RAM and CPU).

3. Device Info

Use this menu option to see data about the drives that are installed in the autoloader.

4. Load Default

Use this menu option to reset all of the options back to the manufacturer's default values. You can use this function if your autoloader is acting abnormally.

5. Update Firmware

Use this utility to update the software in your autoloader. To update, insert the manufacturer's Certified Update CD into the 1st tray and make sure no other discs are in rest of the trays. Then you can press the **Enter** button to update.

Important: You should not upgrade your autoloader's firmware unless your system is becoming unstable or you are advised to do so by Tech Support.

13. Loader Utilities

page 36

Use the Loader Utilities menu options to access the various utilities built into the autoloader. You can scroll between the various options using the **Up** or **Down** button.

1. Drive Alignment

The Drive Alignment menu is used to check the mechanical alignment between the drives and the robotic arm. See "Drive Alignment" on page 36 for more information.

2. Spindle Alignment

The Spindle Alignment menu is used to check the mechanical alignment between the spindles and the robotic arm. See "Spindle Alignment" on page 37 for more information.

3. Disc Separator

Use this utility to tell the system the number of times for the robotic arm to shake the disc it picked up from the input spindle in order to reduce the disc sticking issue. See "Disc Static and Sticky Media Issues" on page 2 for information about disc sticking issue and "Disc Separator" on page 38 for information on using this menu.

4. Z form Maneuver

Use this utility to enable or disable the Z form maneuver. See "Z form Maneuver" on page 38 for information on using this menu.

5. Alignment Protection

Enabling Alignment Protection makes each drive tray quickly slide in and out after a disc has been loaded into it. This ensures that the disc sits properly in the disc indentation of the tray by "shaking" the disc into place. See "Alignment Protection" on page 38.

14. Manage Accounts

page 39

Use this menu option to:

- Create user accounts and passwords to prevent unauthorized use of the autoloader.
- Edit existing user account information, including name and password.
- Delete existing user account(s).
- Enable/Disable this feature.

For additional information, refer to "Introduction to Manage Accounts" on page 10.

15. Shutdown

page 41

Use this menu option to turn off your system. Once you see the "Ready to Power Off" message, you can safely turn off the machine using the power switch. Turning off your autoloader without performing this function increases the risk of damaging it.

16. AUTOCOPY (Hidden)

page 30

The AUTOCOPY function simplifies the copy process by allowing you to stack blank media on a spindle(s), place the master on top of the stack on the first spindle, and press the **Enter** button on *16.AUTOCOPY* key in the main menu. It will load the content of the top disc of the 1st input spindle (master disc) into the Reserved Partition of the Hard Drive and copy it to blank disc(s) below it and other input spindle(s) if exists.

To activate this function, you need to activate it by going to "11. Setup" -> "9.AUTOCOPY" and turn it on.

5. Introduction to Manage Accounts

This feature allows the administrator to:

- Create user accounts and passwords to prevent unauthorized use of the autoloader.
- Edit existing user account information, including name and password.
- Delete existing user account(s).
- Enable or disable “Manage Accounts”.

Manage Accounts is disabled by default. Prior to activating the “Manage Accounts” feature, the autoloader recognizes all users as the Administrator.

The pre-defined password for this function is “0000.”

By adding additional users, each individual user has his/her own settings and only has access to the hard drive partitions that the individual user loaded to the hard drive. No one else can access their hard drive partitions other than the Administrator.

For example, if USER 1 logs-in and loads a master disc to hard drive Partition A, when USER 2 logs-in, USER 2 will not have access to any partitions loaded by USER 1; which includes partition A.

To take advantage of this feature, follow these instructions:

- Change the Administrator password. Refer to “Edit User Info” on page 40 for additional information.
- Create a User Name and Password for each authorized person on this autoloader. Refer to “Create User” on page 40 for additional information.
- Enable the “Manage Accounts” feature by turning on the “Password on Bootup” setting. Refer to “Password on Bootup” on page 41 for additional information.

Note: This autoloader comes with a standard license that allows you to create up to 32 users.

For instructions on how to use “Manage accounts”, see “Manage Accounts” on page 39.

6. Single Master and Multi Master Modes

There are two ways to make copies using the autoloader:

Single Master Mode:

This mode requires that a single master disc is loaded onto the hard drive prior to initiating the duplication process. This mode is ideal if your job involves one or very few master disc(s).

Multi Master Mode (Batch Mode):

This mode does not require you to manually load your master. Simply place the master disc(s) on top of the stack of blank discs needed for that particular job of the master disc. This mode is ideal if you have numerous master discs and fewer copies for each master disc.

The Multi Master mode uses the Reserve partition to temporarily store the content of the current master disc. Once the task is complete and a new master disc has been detected, the reserve partition's content (of previous master disc) will be replaced with the content of the new master disc.

You can tell immediately which mode you are in by looking at any of the Copy or Test menus:

ReflexAuto	B.30
1. Copy	(SM)

ReflexAuto	B.30
1. Copy	(MM)

The (SM) indicates Single Master Mode, and the (MM) indicates Multi Master Mode.

For example, if you need to make:

- 20 copies of job A
- 40 copies of job B
- 30 copies of job C

Under Multi Master Mode, you would need to follow steps below:

1. Make sure all of the spindles are empty.
2. Place 30 blank discs for job C on to the first input spindle.
3. Place the master disc for job C on top of those blank discs for job C.
4. Place 40 blank discs for job B on top of the master disc for job C.
5. Place the master disc for job B on top of those blank discs for job B.
6. Place 20 blank discs for job A on top of the master disc for job B.
7. Place the master disc for job A on top of those blank discs for Job A.

After you have completed these steps, the Input Spindle should be loaded in the order shown in Figure 1-5:

When you start the copy operation, the robotic arm will pick up discs from the Input Spindle and place them into the drives. If any of the discs in the drives contains data, (in this case, that would be the first disc, the Master Disc for job A) the autoloader will load entire content of this disc(Master A) into the reserve partition on the Hard Drive. The subsequent discs from the input bin/spindle will be loaded in the empty drives.

Once the loading process is completed, the autoloader will start the duplication process for the blank media in the remaining drives. Master disc A will be picked up from the appropriate drive and dropped on to the Output Spindle and the empty drive where the master disc was removed will be loaded with the next disc from the input bin.

If a new master is detected before the previous job is finished, the autoloader will complete the first job, unload the completed job, and fill the drive trays with blank discs for the next job.

The robotic arm will continue to load media into the drives as the duplicated discs are placed in the Output Spindles. Once a writer drive (any drive) detects another Master disc, the same process is repeated for the new Master disc.

Master A
20 Blank Job for Master A
Master B
40 Blank Job for Master B
Master C
30 Blank Job for Master C

Figure 1-5
The Order of the Discs

7. Setting Counters and Assigning Names

Two frequently used tasks are setting counters and assigning names to partitions. Directions for these tasks are given here.

7.1 Setting Counters

The autoloader frequently gives you the option to set a counter so that the machine can keep track of the number of copies made. Follow these steps when you see a Counter Selection Menu:

```
Counter:
No Counter
```

The Counter Selection Menu lets you set how many copies you want to make for your project. The Counter Selection feature tells the autoloader to count the number of successful copies you have made and stop the job when the desired number of copies has been reached.

You can select “No Counter” if you prefer to copy continuously with no interruption. (It will still count the number of copies, but it will not notify you when to stop.) To select the “No Counter”, simply press the **Enter** button when you see the screen above.

Or, you can select “Specify Counter” between 1 to 9999 by pressing the **Up** or **Down** button to go to the Specify Counter menu:

```
Counter:
Specify Counter
```

Press the **Enter** button to select this option. You will see the next *Specify Counter* menu.

```
Specify Counter:
[0  ] OK?
```

To specify the number of copies for your project, you need to enter/input a four-digit number.

If you need to specify a number that is less than four digits, fill the leading spaces with zeros (any leading zeros will be skipped). Examples of four-digit numbers are “0234” (two hundred and thirty four), or “0010” (ten).

To enter the number, you need to use the **Up or Down button** to select the number for each digit and use the **Enter** button or the **ESC** button to move the cursor position right or left. Once you've finished, move the cursor to “OK” and press the **Enter** button. For example, if you want to specify a counter value of 21 (twenty one). The 4-digit value would be “0021.” To input the desired quantity, do the following:

Make sure the cursor is located at the first position (First blinking position):

```
Specify Counter:
[0  ] OK?
```

- Press the **Down** button repeatedly until “0” is displayed.
- Press **Enter** button once to move the cursor to the next position.
- Press the **Down** button repeatedly until “0” is displayed.
- Press **Enter** button once to move the cursor to the next position.
- Press the **Down** button repeatedly until “2” is displayed.
- Press **Enter** button once to move the cursor to the next position.
- Press the **Down** button repeatedly until “1” is displayed.
- Now, “0021” is displayed, press **Enter** button once and the cursor moves to “OK”.

Then, press the **Enter** button once to submit your counter value. The loader will now start loading disc from the input spindles and place them into all drive trays.

7.2 Editing Names

When you create either a new user or a partition, you need to assign a name to it. The example shown here shows how to name or rename a partition, but the process for naming or renaming the user name is identical.

During the process of creating a new partition, you will see the Edit Partition Name menu:

```
Edit Partition Name
[          ] OK?
```

To enter the name, use the **Up** or **Down** button to select the character and use the **Enter** or **ESC** button to move the cursor position. Once you've finished, move the cursor to "OK" and press the **Enter** button.

The name for a partition can be up to eight characters long, and the characters can be any alpha (A...Z) or numeric (0...9) value. For example, if you want to name the partition for your master disc as "FUN". Then follow this example:

- Press the **Down** button repeatedly until "F" is displayed. (You can also hold the **Down** button down, and the autoloader will scroll through the alphabet.)
- Press the **Enter** button once to move the cursor to the next position.
- Press the **Down** button repeatedly until "U" is displayed.
- Press the **Enter** button once to move the cursor to the next position.
- Press the **Down** button repeatedly until "N" is displayed.
- Press the **Enter** button once to move the cursor to the next position.
- Once you have the name "FUN" displayed and then, press the **Enter** button repeatedly until the cursor is moved to "OK".
- Then press the Enter button once to submit your name selection.

You will now see the following confirmation screen:

```
Loading Partition?
[FUN          ], OK?
```

Press the Enter button to confirm.

Chapter 2: Operation

This chapter shows each of the menu options and how they are used.

1. Copy

The Copy menu option or the front panel Copy quick key have two different modes of operation:

- **Single Master Mode:** This mode requires that a single master disc is loaded onto the hard drive prior to initiating the duplication process. This mode is ideal if your job involves one or very few master disc(s).
- **Multi Master Mode (Batch Mode):** This mode does not require you to manually load your master. Simply place the master disc(s) on top of the stack of blank discs needed for that particular job of the master disc. This mode is ideal if you have numerous master discs and fewer copies for each master disc.

These modes are described in detail in “Single Master and Multi Master Modes” on page 10. If you are making copies in Single Master Mode, continue on to the next section. If you are making copies in Multi Master Mode, jump ahead to “Making Copies in Multi Master Mode” on page 16.

1.1 Making Copies in Single Master Mode

This process will copy your master disc on to several blank discs simultaneously. This mode requires that your master disc is loaded into a partition on the Hard Drive. See “Load Partition” on page 25 for instructions on how to do this.

Turn on your autoloader and wait until it has booted up. It should take several minutes for the autoloader to go through its self adaptive test and auto-calibration procedures. You should see the following signifying your autoloader is ready:

ReflexAuto	B. 30
1. Copy	(SM)

Make sure the Master Mode is set to Single Master mode (SM). If it is not, use the **Up or Down** button to navigate to the 8. *Master Mode* screen. If it is already in Single Master mode (SM), please skip to the step that starts the copy process.

ReflexAuto	B. 30
8. Master Mode	(MM)

Press the **Enter** button to enter the *Master Mode* Menu and you will see a screen similar to one of the following:

Master Mode: Multi Master
Master Mode: Single Master

Use the **Up or Down** button to select Single Master Mode. Press the Enter button to submit your selection.

Go back to the 1. Copy Menu. Use the **Up** or **Down** button to navigate to the following screen:

```
ReflexAuto      B.30
1. Copy         (SM)
```

Start the Copy Process. Insert your blank discs on to the Input Spindle(s) and press the **Enter** button to enter the 1. Copy menu. You will see the *Choose Partition* menu:

```
Choose Partition
3->[FUN      ]CD
```

Use the **Up** or **Down** button to find the partition where your master disc is stored. Press the **Enter** button to select that Partition. Next, you will see the *Counter Selection* menu:

```
Counter:
No Counter
```

Follow the instructions shown in "Setting Counters" on page 12 to continue. Once the counters have been set, press the **Enter** button to confirm. You will see the *Processing* screen:

```
Preparing...
Please Wait
```

After a short interval, the robotic loader will pick the top disc from the input spindle and place it into one of the drives. As this is happening, you will see a screen similar to below:

```
Loader Processing
Drive 1 <- Input Bin
```

This information screen shows what is happening. In this case, the loader has taken a disc from the input spindle and is placing it into Drive 1.

The loader will continue to remove discs from the input spindle and place those into drives until either all of the drives are full, or the count that you loaded into the counter is reached.

```
Processing...
Please Wait
```

It takes a few seconds for the autoloader to recognize all the discs.

After two or three seconds of processing time, one of the following *Copy Progress* screens will appear.

Copying... H4012MB 0/21 12%
<ul style="list-style-type: none"> ➤ "H" indicates the source of the job resides in the Hard Drive. ➤ "4012MB" indicates the capacity of the master disc. ➤ "12%" indicates the current progress of the duplication. ➤ "0/21" indicates you have a project size of 21 copies and you have made 0 copies so far.

or:

Copying... H4012MB 0 12%
<ul style="list-style-type: none"> ➤ "H" indicates the source of the job resides in the Hard Drive. ➤ "4012MB" indicates the capacity of the master disc. ➤ "12%" indicates the current progress of the duplication. ➤ "0" indicates you have made 0 copies so far.

Note: It is normal to see the progress indicator stay at 0%-10% and 100% for approximately 30 seconds for CD duplication and up to one minute for DVD duplication. That is caused by the initializing and finalizing stages.

```
Loader Processing
Drive 1 -> Output Bin
```

Once the duplication run is completed, the loader will remove the finished disc from the drive and place the successful copy on the Output Spindle and if there are any bad/NG copy to the reject area.

The loader will then pick up another blank disc and load it into the drive. This is then repeated for each disc.

```
Loader Processing
Drive 2 <- Input Bin
```

The copying process will continue until you either run out of blank discs or until the count that you loaded into the counter is reached.

If you run out of blank discs and the job is not complete, the autoloader will give you an opportunity to fill the spindle:

Important: When you add discs to the input spindle, be sure to remove your finished discs from the Output Spindle.

```
Input Bin Empty(20)
Continue?
```

At this point you can either put more discs on to the input spindle and press the **Enter** button to continue, or press the **ESC** button to terminate your project.

Once the autoloader is through, you will see the following screen:

```
PASS 100 FAIL 0
Job Completed! Press OK to Finish
```

- "PASS 100" indicates that you made 100 successful copies.
- "FAIL 0" indicates that you have no failures for this job.

At the bottom of the screen, you will see the scrolling message: "Job Complete! Press OK to Finish"

1.2 Making Copies in Multi Master Mode

This mode does not require you to manually load your master. Simply place the master disc(s) on top of the stack of blank discs needed for that particular job of the master disc. This mode is ideal if you have numerous master discs and fewer copies for each master disc.

The Multi Master mode uses the Reserve partition to temporarily store the content of the current master disc. Once the task is complete and a new master disc has been detected, the reserve partition's content (of the previous master disc) will be replaced with the content of the new master disc.

For more information on Multi Master Mode, see "Single Master and Multi Master Modes" on page 10.

Turn on your autoloader and wait until it has booted up. It should take several minutes for the autoloader to go through its self adaptive test and auto-calibration procedures. You should see the following signifying your autoloader is ready:

```
ReflexAuto      B.30
1. Copy         (MM)
```

Make sure the Master Mode is set to Multi Master mode (MM). If it is not, use the **Up** or **Down** button to navigate to the 8. Master Mode screen. If it is already in Multi Master mode (MM), please skip to the step that starts the copy process.

```
ReflexAuto      B.30
8. Master Mode  (SM)
```

Press the **Enter** button to enter the Master Mode Menu and you will see a screen similar to one of the following:

```

Master Mode:
Single Master
-----
Master Mode:
Multi Master

```

Use the **Up** or **Down** button to select Multi Master Mode. Press the **Enter** button to submit your selection.

```

ReflexAuto      B.30
1. Copy         (MM)

```

Use the **Up** or **Down** button to navigate back to the *1. Copy* Menu.

Place your master discs and blank discs onto the Input Spindle as described in “Single Master and Multi Master Modes” on page 10. In general, the order of the discs on the spindle will be, **from top to bottom**:

- The master disc for the first job
- The blank discs for the first job
- The master disc for the second job
- The blank discs for the second job
- The master disc for the third job
- The blank discs for the third job
- etc.

If your autoloader has more than one Input Spindle, then the job sequence can be spread across the spindles, in sequence. CD duplication jobs and DVD duplication jobs can be intermixed. The autoloader will automatically detect a job's master and blank disc format and copy them when they match.

You should still be at the *1. Copy* Menu:

```

ReflexAuto      B.30
1. Copy         (MM)

```

Press the **Enter** button to start the duplication job.

```

Preparing...
Please Wait

```

After a short interval, the robotic loader will pick the top disc (master disc) from the Input Spindle and place it into one of the drives. As this is happening, you will see a screen similar to below:

```

Loader Processing
Drive 1 <- Input Bin

```

This information screen shows what is happening. In this case, the loader has taken a disc from the Input Spindle and is placing it into Drive 1.

The loader will continue to remove discs from the Input Spindle and place those into drives until either all of the drives are full or all Input Spindles are empty.

```

Processing...
Please Wait

```

It takes a few seconds for the autoloader to recognize all of the discs in the trays.

```

Loading... RESERVED
36%          121MB Loaded

```

Once all of the discs are detected, the autoloader will detect the master disc and read the contents of the master disc into the reserve partition.

```

Loader Processing
Drive 1 -> Output Bin

```

Once the master disc has been loaded, the autoloader will remove the master disc from the drive and place it onto the Output Spindle.

```
Loader Processing
Drive 1 <- Input Bin
```

The loader will then pick up another blank disc and load it into the drive where the last master disc was placed.

Once the loading process is completed, the duplication process will start. When the duplication process is through, the loader will remove the discs from the drives and place successful copies onto the Output Spindles and place failed copies onto Rejected Area.

In Multi Master Mode, the robotic arm continues to load more media into the drives from Input Spindles while the duplicated discs are placed in the Output Spindle. Once a new Master disc are been detected by any of the drives, this process will repeat for the new Master disc.

When all of the jobs are complete, and the autoloader detects all Input Spindles are empty, it presents you with the Input Bin Empty message:

```
Input Bin Empty (20)
Press OK to Continue
```

Press the **Enter** button to continue and you will see the *Access Log File* screen:

```
Access Log File
OK?
```

Press the **Enter** button to view the log file or press the **ESC** button to return to the *1.Copy* menu. If you choose to see the log file, you will see a screen similar to below:

```
Master #1, Total 20
Pass 20, Fail 0
```

```
Master #2, Total 40
Pass 40, Fail 0
```

```
Master #3, Total 30
Pass 30, Fail 0
```

Use the **Up** or **Down** buttons to look at the log file for the various jobs. Press the **ESC** button to return to the *1.Copy* menu

2. Test

Use the *Test* menu or *Test* quick key to simulate the copy process. With simulation, write once recordable discs such as DVD-R, or CDR will be reusable. The purpose of simulation is to ensure error free duplication.

Note: *Due to physical limitations of the DVD+R recordable format, if you try to simulate DVD+R copying, you will encounter failure messages.*

Warning: *If you are using CD/DVD Rewritable discs as your media during the simulation, the content on those discs will be permanently erased.*

Operation in Test mode is identical to operation in Copy mode. See “Copy” on page 14 for instructions.

3. Compare

Use the Compare function to perform a bit-by-bit comparison between the content of your master disc(s) in the Hard Drive and the contents of all discs it copied. This ensures that all of your copies are identical to original master disc(s).

Note: *The bit-by-bit comparison will only apply on all DVDs and Data CDs. The readability check will be applied for other formats like Audio CDs, CD+G, and Video CD discs due to their lack of error correction mechanisms.*

If you are at the 1. Copy Menu, do the following:

```
ReflexAuto      B.30
1. Copy         (MM)
```

Use the **Up** or **Down** button to find the 3. Compare menu.

```
ReflexAuto      B.30
3. Compare
```

Press the **Enter** button on 3. Compare menu to enter the *Choose Partition* Menu and you will see a screen similar to the following:

```
Choose Partition
3-> [FUN      ]CD
```

Use the **Up** or **Down** button to find the partition where your master disc is stored. Press the **Enter** button to select that Partition. Next, you will see the *Counter Selection* menu:

```
Counter:
No Counter
```

Follow the instructions shown in “Setting Counters” on page 12 to continue. Once the counters have been set, press the **Enter** button to confirm. You will see the *Preparing* screen.

```
Preparing...
Please Wait
```

After a short interval, the robotic loader will pick the top disc from the input spindle and place it into one of the drives. As this is happening, you will see a screen similar to below:

```
Loader Processing
Drive 1 <- Input Bin
```

This information screen shows what is happening. In this case, the loader has taken a disc from the input spindle and is placing it into Drive 1.

The loader will continue to remove discs from the input spindle and place those into drives until either all of the drives are full, or the count that you loaded into the counter is reached.

```
Processing...
Please Wait
```

It takes a few seconds for the autoloader to recognize all the discs.

The system will then compare the discs in the trays to the content of the master disc residing in the Hard Drive partition you specified. When the comparison job is complete, the autoloader will place the good discs and failed discs into corresponding areas and you will see a PASS/FAIL result screen similar to this:

Counter Specified	No Counter Specified
PASS 16 FAIL 0 Job Completed! Press OK to Finish	Input Bin Empty (20) Reset Hoppers?
<p>➤ "PASS 16" indicates 16 discs have been compared successfully.</p> <p>➤ "FAIL 0" indicates none of the discs have failed.</p> <p>Press the Enter button to finish</p>	<p>➤ "Input Bin Empty (20)" indicates that the system has run out of discs to compare.</p> <p>If you have more discs to compare, you can empty the Output Spindle; place the discs to be compared in the Input Spindle and Press the Enter button to continue.</p> <p>If you have no more discs to compare, press the ESC button to terminate the operation.</p>

4. Test+Copy

With the Test + Copy menu option, the autoloader simulates the copying process, and then makes copies if everything works correctly. If a failure is encountered on a disc during the simulation, it will not be copied during the copying process while the discs that passed the simulation will move on to the copying process. After the copying process, the autoloader will place the failure discs into the rejected area while the successfully copied discs will be placed into the corresponding Output Spindle.

Operation in *Test+Copy* menu is identical to operation in *Copy* menu. See "Copy" on page 14 for instructions.

5. Copy+Compare

The *Copy + Compare* menu option is used to make verified copies. After the copy process is done, the autoloader automatically compares the copies to the master content residing in the hard drive to ensure that they are identical. When the operation is complete, the autoloader automatically places good discs on to the Output Spindle and bad discs in the Reject Area.

Operation in *Copy+Compare* menu is identical to operation in *Copy* menu. See "Copy" on page 14 for instructions.

6. Select Burn Speed

The *Select Burn Speed* menu option or the *Speed* quick key is used to adjust the duplication speed for the various duplication modes. By default, the duplication speed will be set to the optimal speed. However, under some circumstances you might want to lower down the duplication speed. Those circumstances are:

- Poor Blank Media Quality - When your media quality is sub-par, lowering the duplication speed is necessary to make good copies.
- Duplication Quality - Overall, the lower the speed, the higher the quality of your duplicates. If you have time, it is a good choice to lower the speed to produce the best quality duplicates.

If you are at the 1. Copy Menu, do the following:

```
ReflexAuto      B. 30
1. Copy         (MM)
```

Use the **Up or Down** button to find the 6. *Select Burn Speed* menu.

```
ReflexAuto      B. 30
6. Select Burn Speed
```

Press the Enter button on 6. *Select Burn Speed* menu to set the duplication burn speed and you will see the *Select Burn Speed* type menu similar to below:

```
Select Burn Speed
HDD to CD Speed
```

There are two recording speed types that can be set:

- HDD to CD: Copy Hard Drive CD Content to CD-R/RW Discs speed.
- HDD to DVD: Copy Hard Drive DVD Content to DVD±R/RW Discs.

Depending upon the type of duplication and your autoloader restrictions, you need to select the correct format in order to take effect. To select the recording speed options, use the **Up or Down** buttons to find the desired speed for the appropriate format and press the **Enter** button to enter the menu. You will see a menu similar to this:

```
HDD to CD Speed
32x
```

Use the **Up or Down** button to find the desired speed. Press the **Enter** button to set the desired recording speed.

The options that are available are shown in Table 2-1.

Duplication Type	Speeds Available
HDD to CD Speed	1x, 2x, 4x, 8x, 12x, 16x, 24x, 32x, 40x, 48x, 52x
HDD to DVD Speed	1x, 2x, 2.4x, 4x, 6x, 8x, 12x, 16x

Table 2-1 Duplication Speeds

These options might change depending on the CD or DVD writers pre-installed in your system.

Note: *The speed that you choose may be adjusted by the drives and/or the media for optimized duplication.*

Once your selection has been changed successfully, you will see the following screen for 2 seconds:

```
HDD to CD Speed
Adjusted to: 8x
```

You will automatically be returned to the Main Menu.

7. Select Source

The *Select Source* menu or the *Source* quick key is used to set the Master Reading Source. In the autoloader, the Master Reading Source is always the Hard Drive.

8. Master Mode

The *Master Mode* menu is used to select between Single Master mode or Multi Master mode. For more information on the modes, see “Single Master and Multi Master Modes” on page 10.

If you are at the 1. Copy Menu, do the following:

ReflexAuto	B. 30
1. Copy	(SM)

Use the **Up** or **Down** button to find the 8. *Master Mode* menu.

ReflexAuto	B. 30
8. Master Mode	

Press the Enter button on 8. *Master Mode* to enter the menu and you will see one of the following screens:

Master Mode: Single Master
Master Mode: Multi Master

Use the **Up** or **Down** button to choose between Multi Master mode and Single Master mode. Press the Enter button to enter your selection. The system will return you back to the main menu.

9. Erase RW

Use the *Erase RW* menu to erase your Rewritable discs.

ReflexAuto	B. 30
1. Copy	(SM)

Use the **Up** or **Down** button to find the 9. *Erase RW* menu.

ReflexAuto	B. 30
9. Erase RW	

Press the Enter button on 9. *Erase RW* to enter the menu and you will see the following screens:

Erase RW
Quick Erase

There are two options:

- **Full Erase:** This option erases the entire disc, destroying all previously written data in the process.
- **Quick Erase:** This option erases the index (TOC) of the Rewritable disc, not the data section. It is much faster than Full Erase. However, the data section is still recoverable. In order to ensure all old content on the RW disc is completely erased and unable to be recovered for security purposes, you must utilize the FULL ERASE function.

Use the Up or Down buttons to select between the two options and press the Enter button to continue.

Counter:
No Counter

Follow the instructions shown in “Setting Counters” on page 12 to continue. Once the counters have been set, press the Enter button to confirm.

Loader Processing
Drive 1 <- Input Bin 1

The Robotic Arm will go out and pick the discs to be erased from the Input Spindles and place them into the drives. As soon as the drives are all full, or the number programmed into the counter is reached, you will see the following:

Processing ...
Please Wait

The system will check all discs in the drive and prepare them to be erased. As soon as the checking process completes, the Erase RW process starts.

Quick Erasing...
0/25

The “0” indicates that zero discs have been erased so far. The “25” indicates the number programmed into the counter. Once all the discs have been erased, you will see one of these PASS/FAIL screens:

Counter Specified

PASS 25 FAIL 0
Job Completed! Press OK to Finish

- “PASS 25” indicates 25 discs have been erased successfully.
- “FAIL 0” indicates none of the discs have failed erase.

Press the  **Enter** button to finish

or:

No Counter Specified

Input Bin Empty (20)
Reset Hoppers?

- “Input Bin Empty (20)” indicates that the system has run out of discs to erase.

If you have more discs to erase, you can empty the Output Spindle; place the discs to be erased in the Input Spindle and Press the  **Enter** button to continue.

If you have no more discs to erase, press the  **ESC** button to terminate the operation.

10. Hard Drive Setup

The Hard Drive Setup menu consists of following sub-menus:

- 1 *Select Partition*
- 2 *Load Partition*
- 3 *Rename Partition*
- 4 *Delete Partition*
- 5 *Partition Info*
- 6 *Partition Size*
- 7 *Format Hard Drive*

Each of these menus is discussed in it's own subsection.

If you are at the 1. Copy Menu, do the following:

```
ReflexAuto    B.30
1. Copy       (SM)
```

Use the **Up or Down** button to find the *10. Hard Drive Setup*.

```
ReflexAuto    B.30
10. Hard Drive Setup
```

Press the **Enter** button on *10. Hard Drive Setup* to enter the menu. Use the **Up or Down** button to select between those options.

10.1 Select Partition

The *Select Partition* submenu is used to select the partition on the Hard Drive that will be used as the default partition choice for various Hard Drive related tasks.

```
Hard Drive Setup
1. Select Partition
```

Press the **Enter** button to enter the *Select Partition* menu.

```
Choose Partition
1->[RESERVED] CD
```

Use the **Up or Down** button to select the desired partition. The RESERVED partition is reserved for use by the System under Multi-Master mode.

```
Choose Partition
2->[FUN    ] CD
```

Press the **Enter** button to select the desired partition (named FUN in this example).

10.2 Load Partition

The Load Partition menu is used to load a master disc's content into the desired partition on the Hard Drive.

```
Hard Drive Setup
2. Load Partition
```

Press the **Enter** button to enter the *Load Partition* menu.

```
Load Partition[2/16]
Load -> New Partition
```

If you would like to load the master disc into a new partition, press the **Enter** button when the *New Partition* option is shown. Or, you can use the **Up** or **Down** button to select one of the existing partitions to be overwritten & press the **Enter** button to select it.

Depending on whether you are loading the master into a new partition, or into an existing partition, you will see one of these two screens:

New Partition

```
Edit Partition Name
[          ] OK?
```

Enter a new partition name as described in "Editing Names" on page 13. For this example, we will name it "Happy".

or:

Existing Partition

```
This will Overwrite
[FUN          ],OK?
```

Press the **Enter** button to overwrite the partition named "FUN". Before continuing, the autoloader will ask you again to confirm it.

```
Edit Partition Name
[FUN          ] OK?
```

Enter a new partition name as described in "Editing Names" on page 13. For this example, we will name it "HAPPY".

```
Load Partition
[HAPPY      ], OK?
```

The system will display a verification message before continuing. Press the **Enter** button to start loading the partition named "HAPPY".

The master should be placed on the first input spindle. The robotic arm will pick it up and place it into one of the drives, and the contents of the master disc will be loaded into the desired partition.

```
Load Partition OK!
Press OK to Finish
```

Press the **Enter** button to finish.

10.3 Rename Partition

When you load your master disc onto a hard drive partition, you are asked to give it a name. However, you can rename it at anytime afterwards. Instructions for this are shown in "Editing Names" on page 13.

10.4 Delete Partition

The *Delete Partition* option deletes an existing partition. Use the **Up** or **Down** button to navigate to the 4. *Delete Partition* menu.

```
Hard Drive Setup
4. Delete Partition
```

Press the **Enter** button to enter the *Delete Partition* menu. The autoloader will first ask you to choose the partition to be deleted:

```
Choose Partition
2->[FUN      ] CD
```

Use the **Up** or **Down** button to find the partition that you want to delete. Press the **Enter** button to select the partition.

```
Delete Partition
[FUN      ] CD, OK?
```

The autoloader displays the *Delete Partition* confirmation message. Press the **Enter** button to continue.

```
Partition FUN
Deleted
```

The autoloader displays the *Deleted* message for two seconds and then returns you to the *Delete Partition* menu.

10.5 Partition Info

The *Partition Info* option provides information about an existing partition. Use the **Up** or **Down** button to navigate to the 5. *Partition Info* menu.

```
Hard Drive Setup
5. Partition Info
```

Press the **Enter** button to enter the *Partition Info* menu, and use the **Up** or **Down** button to find the partition that you want information about.

```
( 2) From: ADMIN
[FUN      ] CD 21MB
```

- The “(2)” field indicates that it is the second partition on the drive.
- The “From:” field indicates the user that created the partition (See “Introduction to Manage Accounts” on page 10.)
- The “[FUN]” field shows the name of the partition.
- The “CD” field indicates that the master stored in this partition is a CD rather than a DVD.
- The “21MB” field indicates that the capacity of the master’s content stored in this partition.

10.6 Partition Size

The *Partition Size* option allows you to change the size of the Hard Drive partitions.

Warning: When you alter the partition size, all previous data or video stored on the hard drive will be lost, and you will only be able to load media with less than the specified partition size capacity.

To change the hard drive partition size, use the **Up** or **Down** button to navigate to the 6. *Partition Size* menu:

```
Hard Drive Setup
6. Partition Size
```

Press the **Enter** button to enter the *Partition Size* menu.

```
Partition Size
AUTO
```

Press the **Up** or **Down** button to select the desired partition size. Press the **Enter** button to select the *Partition Size*. The Hard Drive is divided into a number of equal-sized partitions. Each

partition holds ONE and ONLY ONE master disc's content regardless of the size of your master disc.

The options for partition size are:

- Auto
- CD: 1 GB
- DVD Single Layer: 5 GB
- DVD Dual/Double Layer: 9 GB

The number of partitions is determined by dividing your Hard Drive's total capacity by the selected media size: 1 GB for CD format, 5 GB for DVD5 format, or 9 GB for DVD9 format (double layer/dual layer), and then subtracting one partition for system use. For example, if you have a 160 GB Hard Drive, you can calculate the number of DVD5 format partitions by: $160 / 5 = 32$. Since one partition is reserved for system use, you will have 31 partitions available for use.

Or you can calculate the number of DVD9 format partitions using the formula: $160 / 9 = 17.77$. Since you cannot use an incomplete partition, there will be a total of 17 partitions available for a 160 GB Hard Drive. Since one partition is reserved for system use; there will be 16 partitions available for use.

The *Auto* option sets the partition to the largest size that the installed CD/ DVD writers can accommodate.

If you have a 16x speed or higher autoloader with double layer/dual layer DVD9 capabilities, the hard drive partitions are set at a size of 9 GB each under *Auto* option to accommodate the expanded size of the DVD9 format. If you require more partitions and do not plan on copying double layer/dual layer DVD9 media, you can change the hard drive partition size to CD (1 GB) or DVD (5 GB).

10.7 Format Hard Drive

This function formats the Hard Drive. It deletes all disc images and re-initiates the Hard Drive. To format the Hard Drive, use the **Up** or **Down** button to navigate to the 7. *Format Hard Drive* menu:

```
Hard Drive Setup
7. Format Hard Drive
```

Press the **Enter** button to enter the *Format Hard Drive* menu.

```
Format Hard Drive
Press OK to Continue
```

Press the **Enter** button to format the Hard Drive. After the Hard Drive has been formatted, the system will return you to the *Format Hard Drive* menu.

11. Setup

The 11.Setup menu options are used to configure various options on the autoloader. The Setup menu consists of the following sub-menus:

- Language
- Read Error Skip
- CD Writing Mode
- Max Audio, VCD & CDG Speed
- Buzzer
- Startup Menu
- Screen Saver
- Counter
- AUTOCOPY Enabled
- DVD+R Compatibility Mode
- Disable Drives

Each of these options is discussed in its own subsection.

11.1 Language

This setting allows you to choose the language that you prefer to use when navigating the autoloader. The autoloader supports multiple languages.

Setup 1. Language

Use the **Up** or **Down** button to select the Language menu and press the **Enter** button to enter that menu.

Language: English
Language: Español

Use the **Up** or **Down** button to select between the languages and press the **Enter** button to select that option.

11.2 Read Error Skip

Normally, when the autoloader encounters a read error while reading your master disc, the duplication is aborted and all the recordable media in the writers are ruined. However, if you believe that your master disc has a small, insignificant error due to physical damage, you can enable this setting to allow the autoloader to skip any read errors it encounters.

Note: *This function does not fix the error; it only skips it to make the rest of the data readable.*

Setup 2. Read Error Skip

Use the **Up** or **Down** button to select the *Read Error Skip* menu and press the **Enter** button to enter that menu.

Read Error Skip On
Read Error Skip Off

Use the **Up** or **Down** button to select whether *Read Error Skip* is on or off, and press the **Enter** button to select that option.

11.3 CD Writing Mode

This setting allows you to select which mode to use to duplicate a CD; “Disc at Once” or “Track at Once.” Unless you understand completely what these modes are, we strongly suggest you to set it to “Disc at Once.”

Setup 3. CD Writing Mode

Use the **Up** or **Down** button to select the *CD Writing Mode* menu and press the **Enter** button to enter that menu.

CD Writing Mode Disc at Once
CD Writing Mode Track at Once

Use the **Up** or **Down** button to select either *Disc at Once* or *Track at Once*, and press the **Enter** button to select that option.

11.4 Max Audio, VCD & CDG Speed

Due to the lack of error checking mechanism for Audio CD, Video CD and CD+G format, duplicating them at too high a speed can cause frequent errors like glitches and skips. Use this setting to adjust the maximum duplication speed for Audio, Video CD and CD+G format to ensure reliable duplication for such formats.

The options are: 1x, 2x, 4x, 8x, 12x, 16x, 24x, 32x, 40x, 48x, and 52x.

Setup 4. Max Audio, VCD & CDG Speed
--

Use the **Up** or **Down** button to select the *Max Audio, VCD & CDG Speed* menu and press the **Enter** button to enter that menu.

Max Audio, VCD & CDG Speed 16x

Use the **Up** or **Down** button to select the desired maximum writing speed for Audio, VCD and CDG, and press the **Enter** button to select that option.

Note: *The actual speed that is selected may be determined by the drives or by the blank media.*

11.5 Buzzer

This setting will allow you to choose whether you want to hear a beep when you press a button or when a task has been completed.

Setup 5. Buzzer

Use the **Up** or **Down** button to select the *Buzzer* menu and press the **Enter** button to enter that menu.

Buzzer : On
Buzzer : Off

Use the **Up** or **Down** button to select whether *Buzzer* is on or off, and press the **Enter** button to select that option.

11.6 Startup Menu

This setting will allow you to choose the menu option that you will see first when you turn on the autoloader. The options are:

- Copy
- Test
- Compare
- Test+Copy
- Copy+Compare
- Select Burn Speed
- Select Source
- Master Mode
- Erase RW
- Hard Drive Setup
- Setup
- Loader Utilities
- System Utilities
- Manage Accounts
- Shutdown

Setup
6. Startup Menu

Use the **Up** or **Down** button to select the *Startup Menu* option and press the **Enter** button to enter that menu.

Startup Menu
Copy

Use the **Up** or **Down** button to select the desired startup menu, and press the **Enter** button to select that option.

11.7 Screen Saver

This menu allows you to choose whether you want to enable the Screen Saver feature. By enabling this feature, a screen saver will be displayed when your autoloader has been idle for a long period of time.

Setup
7. Screen Saver

Use the **Up** or **Down** buttons to select the *Screen Saver* menu and press the **Enter** button to enter that menu.

Screen Saver:
On

Screen Saver:
Off

Use the **Up** or **Down** button to select whether the *Screen Saver* is on or off, and press the **Enter** button to select that option.

11.8. Counter

This menu allows you to choose whether you want to enable the *Counter* feature. By enabling this feature, the autoloader will prompt you to enter a counter amount and continuously burn discs until it reaches the value set into the counter.

Setup
8. Counter

Use the **Up** or **Down** button to select the *Counter* menu and press the **Enter** button to enter that menu.

Counter:
On

Counter:
Off

Use the **Up** or **Down** button to select whether the *Counter* is on or off, and press the **Enter** button to select that option.

For information on entering the counters, see “Setting Counters and Assigning Names” on page 12.

11.9 AUTOCOPY Enabled

This option turns on the hidden Autocopy menu. The Autocopy function is the simplest way to make CD/DVD copies. It simplifies the copy process by automatically copying from the Master Disc, which should be placed on top of the first Input Spindle, to all of the blank discs which follow it. To make copies in Autocopy mode, you simply:

- Fill the input spindle(s) with the required number of blank discs
- Place the Master disc on top of the stack in the first input spindle
- Press the 16. *AUTOCOPY* button

When *AUTOCOPY Enabled* is turned on, it appears as 16. *AUTOCOPY* above option 1. *Copy* and below option 15. *Shutdown* in the main menu structure.

```
Setup
9. AUTOCOPY Enabled
```

Use the **Up or Down** button to select the *AUTOCOPY Enabled* menu and press the **Enter** button to enter that menu.

```
AUTOCOPY Enabled:
On
AUTOCOPY Enabled:
Off
```

Use the **Up or Down** button to select whether the *AUTOCOPY Enabled* function is on or off, and press the **Enter** button to select that option.

Once you get back to the main menu, use the **Up or Down** button to navigate to the following screen:

```
ReflexAuto      B.30
16. AUTOCOPY
```

Fill the input spindle(s) with the required number of blank discs. Place the Master disc on top of the stack in the first input spindle, and press the **Enter** button to start the AUTOCOPY process.

```
Loader Processing...
Please Wait
```

The loader will then start the Autocopy process.

```
Loader Processing
Drive 1<-Input Bin
```

The loader will load the Master into the next available drive.

```
Loading...  RESERVED
60%          4012MB
```

The loader will load the contents of the master disc into the RESERVED partition.

Once the content of the master disc has been loaded, the autoloader removes it from the drive, places it on the output spindle, and starts placing blank discs into the writer drives.

```
Loader Processing
Drive 2<-Input Bin
```

This information screen shows what is happening. In this case, the loader has taken a disc from the input spindle and is placing it into Drive 2.

The loader will continue to remove discs from the input spindle and place them into drives until either all of the drives are full, or until it runs out of blank discs.

```
Processing...
Please Wait
```

It takes a few seconds for the autoloader to recognize all the discs.

After two or three seconds of processing time, the following *Copy Progress* screen will appear.

```
Copying...   H4012MB
0           12%
```

- “H” indicates the source of the job resides in the Hard Drive.
 - “4012MB” indicates the capacity of the master disc.
 - “12%” indicates the current progress of the duplication.
- “0” indicates you have made 0 copies so far.

Note: It is normal to see the progress indicator stay at 0% - 10% and 100% for approximately 30 seconds for CD duplication and up to one minute for DVD duplication. That is caused by the initializing and finalizing stages.

Once the duplication run is completed, the loader will remove the disc from the drive and will place either the successful copy on the output spindle or the bad copy in the reject area.

The loader will then pick up another blank disc and load it into the drive. This is then repeated for each drive.

```
Loader Processing...
Drive 2<-Input Bin
```

The copying process will continue until you run out of blank discs.

```
Input Bin Empty(20)
Reset Hoppers?
```

At this point you can either load more discs on to the input spindle(s) and press the **Enter** button to continue, or press the **ESC** button to terminate your project.

11.10 DVD+R High Compatibility Mode

This feature allows you to turn the DVD+R High Compatibility Mode feature ON or OFF. The purpose of this feature is to increase the compatibility of DVD+R media with a broader range of DVD Video players. This process will increase the amount of time required to duplicate your disc(s).

```
Setup
10.DVD+R High Compatibility Mode
```

Use the **Up** or **Down** button to select the *DVD+R High Compatibility Mode* menu and press the **Enter** button to enter that menu.

```
DVD+R High Compatibility Mode:
On
-----
DVD+R High Compatibility Mode:
Off
```

Use the **Up** or **Down** button to select whether the *DVD+R High Compatibility Mode* is on or off, and press the **Enter** button to select that option.

11.11 Disable Drives

This feature allows you to disable certain drives/trays when those drives/trays are producing high failure rates or not functioning properly.

```
Setup
10. Disable Drives
```

Use the **Up** or **Down** button to select the *Disable Drives* menu and press the **Enter** button to enter that menu.

```
Drive 1 Port 1
[*]Enable [ ]Disable
-----
Drive 1 Port 1
[ ]Enable [*]Disable
```

Use the **Up** or **Down** button to select the desired drive/trays you would like to enable/disable. Then press **ENT** or **ESC** button to move the asterisk in front of “Enable” or “Disable”

Save Changes?

Use the **Up or Down** button until you see the "Save Changes" screen and press the **Enter** button to save the changes you made.

Setting Saved!
Please Restart

Once the changes are saved, you shall see the "Please Restart" screen and restart the system to have the new setting take effect.

12. System Utilities

System Utilities is used to provide information pertaining to the autoloader as well as modification to maintain proper functioning. The System Utilities are:

- Disc Info
- System Info
- Device Info
- Load Default
- Update Firmware

12.1 Disc Info

If you are uncertain about the type of blank recordable media you are using, the Disc Info function can help you identify the type of disc and provide information about the data encoded on the disc. For blank recordable discs, it will tell you the media's format, capacity, and the Media's certified writing speed.

Note: *The Disc Info function does not use the robotic capabilities of the system. You must manually insert the discs into the drives.*

System Utilities
1. Disc Info

Use the **Up or Down** button to select the *Disc Info* menu and press the **Enter** button to enter that menu. The system will proceed to the *Please Insert Disc* menu.

Disc Info
Please Insert Disc

Place your disc(s) into the drives.

Disc Info
3 Disc Detected, GO?

After a few seconds, the system will detect the discs and ask you if you want to proceed. Wait until all of your discs have been detected and press the **Enter** button to continue.

The information that you see will depend on whether the disc that you inserted has data written on it or if it is blank. In this example, three discs have been loaded:

Tray 1 has a CD-ROM with data encoded onto it.
Tray 2 has a blank 24x CD-RW media
Tray 3 has a blank 8x DVD-R Media

The results are:

- | | |
|----------------------------------|--|
| 1. CD 21M Data
1 Session 1Trk | A data CD was placed in the top tray <ul style="list-style-type: none">➤ The “1.” Indicates that the information is for the media inserted in the tray 1.➤ The “CD” indicates that the media inserted is a CD-ROM.➤ The “21M” indicates that 21Mbytes of data is encoded on the disc.➤ “1Session 1Trk” indicates that the data is all in a single session recorded as a single track. |
|----------------------------------|--|

Press the **Down** button to see the next disc.

- | | |
|---|---|
| 2. CD-RW 702M Blank
INFODISC 97m25s31f | A blank 24x CD-RW media was placed in the second tray. <ul style="list-style-type: none">➤ The “2.” Indicates that the information is for the media inserted in tray 2.➤ The “CD-RW” indicates that the media inserted is a CD-RW.➤ The “702M” indicates that 702Mbytes of space is available on the disc.➤ “Blank” indicates that the disc is blank.➤ “INFODISC 97m25s31f” is the media ID code. |
|---|---|

Press the **Down** button to see the next disc.

- | | |
|-------------------------------------|---|
| 3. DVD-R 4488M Blank
8x SONY08D1 | A blank 8x DVD-R media was placed in the third tray. <ul style="list-style-type: none">➤ The “3.” Indicates that the information is for the media inserted in tray 3.➤ The “DVD-R” indicates that the media inserted is a –R type of recordable DVD.➤ The “4488M” indicates that 4488Mbytes of space is available on the disc.➤ “Blank” indicates that the disc is blank.➤ “8x” indicates that the disc is certified for 8x duplication.➤ “SONY08D1” is the media ID code. |
|-------------------------------------|---|

Press the **Down** button to go back to the first disc or the **ESC** button to go back to the *System Utilities* menu.

12.2 System Info

The System Info menu provides information about your autoloader including the firmware version, CPU type, and RAM capacity. You can scroll through the various specifications by pressing the **Up** or **Down** button.

- | | |
|---|--|
| System Utilities
2. System Info | Use the Up or Down button to select the System Info menu and press the Enter button to enter that menu. |
| Firmware Version
B.30-08/22/05R06.06 | The first information that is shown is the firmware version. Because the information is larger than the line width, the information will scroll. Press the Down button to go to the next display. |
| CPU
1.6 GHz CPU | The next screen shows the CPU speed. Press the Down button to go to the next display. |
| RAM
128 MB SDRAM | |

The next screen shows the amount and type of memory installed. Press the **Down** button to cycle back to the firmware version display.

The information that you see will differ depending on the system you have.

12.3 Device Info

This menu allows you to see information about the devices built inside your autoloader. This information includes, but is not limited to, manufacturer, model number, etc.

```
System Utilities
3. Device Info
```

Use the **Up** or **Down** button to select the *Device Info* menu and press the **Enter** button to enter that menu.

```
00 Port 0 [TM100-30]
SAMSUNG SP1604N
```

The first information that is shown is the Hard Drive information (if a HDD is installed). The system uses several different kinds of Hard Drives, so the information that you see might be different. Press the **Down** button to go to the next display.

```
01 Port 2 [1.08]
PLEXTOR DVDR PX716
```

The next screen shows information about the first Writer drive. Press the **Down** button to go to the next Writer drive. Press the **ESC** button to return to the *System Utilities* menu.

12.4 Load Default

This function will reset all of the options back to the manufacturer's default settings. You should only perform this function if your autoloader is acting abnormally.

```
System Utilities
4. Load Default
```

Use the **Up** or **Down** button to select the *Load Default* menu and press the **Enter** button to enter that menu.

```
Load Default
Press OK to Continue
```

Press the **Enter** button to load the default parameters or the **ESC** button to return to the *System Utilities* menu.

12.5 Update Firmware

This function will update the software of your autoloader. To update, you need to insert the manufacturer's Certified Update CD into the 1st tray and select this function by pressing the Enter button. We strongly suggest that you not upgrade your autoloader's firmware unless your autoloader has become unstable or you are instructed to do so by Tech Support.

Warning: *When you update the firmware on your system, there may be a chance that you will lose all of the data (contents of master discs) stored in the user HDD partitions. Make sure that you have all of your data on the HDD backed up before attempting this procedure.*

```
System Utilities
5. Update Firmware
```

Use the **Up** or **Down** button to select the *Update Firmware* menu and press the **Enter** button to enter that menu.

```
Waiting for Update
Please Insert Disc
```

Insert the disc containing the firmware into the 1st tray and make sure there are no other discs in any other trays. After a few moments, the system will detect the disc.

```
Firmware verified!
Ready to Update
```

The Autoloader will verify the integrity of the firmware disc before continuing.

```
Autoloader
Updating...      33%
```

The Autoloader displays a progress screen as the update loads.

```
Update Complete!
Please restart
```

When the update is complete, the autoloader displays this message. Power down the Autoloader and power the system back on to complete the update.

13. Loader Utilities

The Loader Utilities menu consists of these submenus:

- Drive Alignment
- Spindle Alignment
- Disc Separator
- Z form maneuver
- Alignment Protection

Each submenu has a section that describes it.

13.1 Drive Alignment

The Drive Alignment menu option is used to check the alignment of the drive trays to the robotic arm. When the Drive Alignment function is selected, the system picks a disc from the first input spindle and moves it to just (1/4 inch) above the drive tray and holds it there.

To start the alignment, place a disc on to the first input spindle.

```
Loader Utilities
1. Drive Alignment
```

Use the **Up or Down** button to select the *Drive Alignment* menu and press the **Enter** button to enter that menu. The system will proceed to the *Please Select Drive* menu.

```
Please Select Drive
Drive 1           Go?
```

Use the **Up or Down** button to select the drive that you want to align and press the **Enter** button to select it.

The autoloader will pick a disc from the first input spindle, move it to ¼ inch above the drive tray, and hold it there. You will see the Drive Alignment screen:

```
Drive Alignment
Alignment Finished?
```

Check the alignment of the drive trays and press the **Enter** button when you are finished.

Note: If the drive trays are not properly aligned and there is a need to re-align them, please contact Disc Makers technical support department at techsupport@discmakers.com for information regarding setting alignments.

Warning: This function is *ONLY* for checking the alignment, *NOT* for setting the alignment. Please do not move the robotic arm with your hands during this process.

When you have finished checking the alignment of the drive(s), the robotic arm will move the disc to the arms top position and hold it there. You will see the *Alignment Next* menu.

Drive Alignment
Alignment Next?

Press the **Enter** button to return back to the *Please Select Drive* menu. This allows you to complete the alignment checking procedure for each of the installed drives.
If you are through checking the alignment of drives, press the **ESC** button to go back to the *Loader Utility* Menu.

When the drive alignment checking process is complete, the robotic arm will drop the disc in the Reject Area.

13.2 Spindle Alignment

The Spindle Alignment menu option is used to check the alignment of the spindles to the robotic arm. When the Spindle Alignment function is selected, the system picks a disc from the first input spindle and holds it approximately one inch above the target spindle.

To start the alignment, place a disc on to the first input spindle.

Loader Utilities
2. Spindle Alignment

Use the **Up or Down** button to select the Spindle Alignment menu and press the **Enter** button to enter that menu. The autoloader will proceed to the *Please Select Spindle* menu.

Please Select Spindle
Spindle 1 Go?

Use the **Up or Down** button to select the spindle that you want to check and press the **Enter** button to select it.

The autoloader will pick a disc from the input spindle, move it to one inch above the spindle being aligned, and hold it there. You will see the *Spindle Alignment* screen:

Spindle Alignment
Alignment Finished?

Pressing the **Up or Down** button will move the spindle up or down approximately 1/2" per press. You should always align the spindle at its mid-point. Press the **Down** button repeatedly to lower the robotic arm to the mid-point and check the alignment.

Note: If the spindles are not properly aligned and there is a need to re-align them, please contact Tech Support Service for information regarding setting alignments.

Warning: This function is *ONLY* for checking the alignment, *NOT* for setting the alignment. Please do not move the robotic arm with your hands during this process.

Once you are done, press the **Enter** button. This will send you to the *Alignment Next* menu.

Spindle Alignment
Alignment Next?

Press the **Enter** button to return back to the *Please Select Spindle* menu. This allows you to complete the alignment checking procedure for each of the installed spindles.
If you are through checking the alignment of spindles, press the **ESC** button to go back to the *Loader Utility* Menu.

When the spindle alignment checking process is complete, the robotic arm will drop the disc in the Reject Area.

13.3 Disc Separator

The *Disc Separator* option is used to circumvent the disc static and sticky media problem. See “Disc Static and Sticky Media Issues” on page 2. When this option is enabled, after picking up a disc from the input spindle, the robotic arm stops at the top of its travel and then bounces down once, twice, or three times to dislodge discs that are stuck together.

To enable the disc separator function:

Loader Utilities 3. Disc Separator

Use the **Up** or **Down** button to select the *Disc Separator* menu and press the **Enter** button to enter that menu.

Disc Separator: Separator Off
Disc Separator: Single Vibration
Disc Separator: Double Vibration
Disc Separator: Triple Vibration

Use the **Up** or **Down** button to select the separator option that you want, and press the **Enter** button to select it.

13.4 Z form Maneuver

Some drives have bezels that extend out from the front of the drive face. This can cause the disc to catch on the edge of the bezel of a higher drive as it is being lowered into one of the below drives. Enabling the Z form Maneuver will allow the robotic arm to lower the disc off center from the front of the drives to clear any protruding obstacles like the bezels, and then center the disc directly above the extended writer tray just before the disc is loaded.

To enable the Z form Maneuver function:

Loader Utilities 4. Z form Maneuver
--

Use the **Up** or **Down** button to select the *Z form Maneuver* menu and press the **Enter** button to enter that menu.

Z form Maneuver On
Z form Maneuver Off

Use the **Up** or **Down** button to select whether the Z form Maneuver is on or off, and press the **Enter** button to select that option.

13.5 Alignment Protection

Enabling Alignment Protection causes each drive tray to quickly slide in and out after a disc has been loaded into it. This ensures that the disc is set properly in the disc indentation in the tray by “shaking” the disc into place.

For example, if the disc is not placed squarely in the center as it should be, but rather slightly off the lip, the “shake” will cause the disc to slide into position in the center of the tray.

To enable the Alignment Protection function:

```
Loader Utilities
5.Alignment Protection
```

Use the **Up** or **Down** button to select the *Alignment Protection* menu and press the **Enter** button to enter that menu.

```
Alignment Protection
On
Alignment Protection
Off
```

Use the **Up** or **Down** button to select whether *Alignment Protection* is on or off, and press the **Enter** button to select that option.

14. Manage Accounts

This feature allows the administrator to:

- Create user accounts and passwords to prevent unauthorized use of this autoloader.
- Edit existing user account information, including name and password.
- Delete existing user account(s).

For complete information on Manage Accounts, see “Introduction to Manage Accounts” on page 10.

To access the Manage Accounts feature, you need to perform the following tasks:

```
ReflexAuto      B.30
14.Manage Accounts
```

Use the **Up** or **Down** button to select the *Manage Accounts* menu and press the **Enter** button to enter that menu. You will be shown the *Enter Password* menu.

```
Enter PWD
[      ] OK?
```

The system will ask you for the Administrator's Password.

The default Administrator's Password is “0000.” To enter, press the **Up** or **Down** button to select the first digit of your password and press the **Enter** button to submit the current digit. You will automatically move to the next digit. Repeat these steps until you've selected all four digits for your password. After you have entered the password, press the **Enter** button “OK” to submit your password.

Once your password is validated, you will be guided to the main Manage Accounts screen:

```
Manage Accounts
1. View User
```

The submenus of Manage Accounts are discussed in the sections that follow.

14.1 View User

This menu allows you to view current existing user accounts.

Note: User “Admin” is the administrative account. It will always be there.

```
Manage Accounts
1. View User
```

Press the **Enter** button to enter this menu

```
View User
1. [ADMIN  ]
```

Use the **Up** or **Down** button to scroll through the list of users. Press the **ESC** button to go back to the *Manage Accounts* menu.

14.2 Create User

This menu allows you to create additional user accounts. Each user has their own settings and hard drive partitions. During this process, you will be prompted to enter a new username and user password for a new account.

Note: The User name consists of a maximum of eight alphanumeric letters or numbers.

Note: The User password consists of four numbers.

Manage Accounts 2. Create User	Press the Enter button to enter this menu.
Edit User's Name [RALPH] OK?	Enter the user's name using the instructions shown in "Setting Counters and Assigning Names" on page 12 . Press the Enter button to move on to the Enter Password stage.
Enter PWD [0] OK?	Enter the user's password using the instructions shown in "Setting Counters and Assigning Names" on page 12 . Press the Enter to complete.
User Ralph Added!	The autoloader will display a confirmation message and automatically return you to the Manage Accounts menu.

14.3 Edit User Info

The Edit User Info menu allows you to change the existing user's account name and password. During this process, you will be asked to select the existing account and then you will be prompted to enter the new user name and new user password for this account.

Note: User "Admin" is the administrative account, you cannot change the user name for this account, but can change the password for this account.

Note: The User name consists of a maximum of eight alphanumeric letters or numbers.

Note: The User password consists of four numbers.

Manage Accounts 3. Edit User Info	Press the Enter button to enter this menu.
Edit User Info 1. [ADMIN]	Use the Up or Down button to scroll through the list of users. Press the Enter button to select user.
Edit User's Name [RALPH] OK?	Edit the user's name using the instructions shown in "Setting Counters and Assigning Names" on page 12. Press the Enter button to move on to the <i>Enter Password</i> stage.
Enter PWD [0] OK?	Enter the new password for this user via the instructions shown in "Setting Counters and Assigning Names" on page 12. Press the Enter button to complete.
User Ralph Changed!	The autoloader will display a confirmation message, and automatically return you to the Manage Accounts menu.

14.4 Delete User

This menu allows you to delete the existing user account. During this process, you will be asked to select the existing account to be removed.

Note: The user “Admin” is the administrative account; you can’t delete this account.

```
Manage Accounts
4. Delete User
```

Press the **Enter** button to enter into this menu.

```
Delete User
3. [RALPH  ]
```

Use the **Up** or **Down** button to scroll through the list of users. Press the **Enter** button to select the user to delete.

```
Delete User
[RALPH  ] OK?
```

The autoloader will ask you to confirm the deletion. Press the **Enter** button to delete the user.

```
User Ralph
Deleted!
```

The autoloader will display a confirmation message, and automatically return you to the Manage Accounts menu.

14.5 Password on Bootup

This menu allows you to enable or disable the Password on Bootup feature. During this process, you will be asked to select “Yes” or “No” (enable or disable).

```
Manage Accounts
5. Password on Bootup
```

Press the **Enter** button to enter into this menu.

```
Password on Bootup:
Yes
```

Use the **Up** or **Down** button to select either Yes or No. Press the **Enter** button to enter the selection.

15. Shutdown

This function will make sure it is safe to turn off your autoloader. Once you see “Ready to Power Off” message, then you can safely turn off the machine using the power switch.

Turning off your autoloader without performing this function will increase the risk of damaging your autoloader.

```
ReflexAuto      B.30
15.Shutdown
```

Press the **Enter** button to enter into this menu.

```
Shutdown
Press OK to Shutdown
```

Press the **Enter** button to shut down the autoloader. The autoloader will do all of its internal housekeeping and then display a confirmation message:

```
Shutdown
Ready to Power Off
```

Press the power button to power off the system.

Chapter 3: Trouble Shooting and Error Codes

No display on LCD or the unit does not operate when the power is on.

- Check the connections for the power cable and ensure that the power outlet is working correctly.
- Make sure that the rear-panel power voltage setting matches the voltage of your power outlet.
- If the autoloader was stored in a location where the temperature dropped below 32°F (0°C) within the past 24 hours, leave the autoloader in a warm room with a temperature of at least 65°F (19°C) for four hours prior to powering the autoloader on.

Drives cannot read disc and shows error message.

- Check the format of the master CD/DVD
- Check the master CD/DVD itself for damage.
- Your master disc may be copy protected. Normally, most of the DVDs and some of the CDs you purchase from stores have been copy protected.

Buttons do not function.

- The autoloader may still be busy performing a task. Give it some time and press the button again. To interrupt the currently running process, press the **ESC** button and hold it for several seconds. If it still doesn't work, turn the machine off, and then restart the machine after a minute.

Copy completed, but the copies are not readable / executable.

- Use the "compare" feature to check the copied disc (data discs only).
- Based on our experience, the quality of your media plays a big role on this part. Try to use high quality media to prevent such problems.
- Use another DVD/CD player/ROM to test the copied media. Sometimes, your DVD/CD Player/ROM may not be compatible with recordable DVD/CD disc.

The failure rate is high.

- Lower the "write speed" and try again. See "Select Burn Speed" on page 21.
- The quality of your blank discs may be poor.
- The quality of your master disc may be poor.

Do I need to upgrade my autoloader's firmware?

- Unless your system is getting unstable, we strongly suggest not upgrading your autoloader's firmware. Please contact our Tech Support if your system is getting unstable.

Cannot boot-up or fails to upgrade firmware.

- Contact our Tech Support.

Can I load data directly from my computer to my autoloader's Hard Drive?

- No, your autoloader's Hard Drive has a unique file system that computers will not recognize. Thus, you can't perform any read/write operations to the Hard Drive from your computer.

Why won't some drives copy?

- Reset the system settings back to default. (See "Load Default" on page 35)
- Drives are consumable parts and every drives comes with a lifespan. After a period of time, they do tend to wear out. Please contact Tech Support Service for assistance.
F.Y.I - Replacing any component of the autoloader without Tech Support Service's consent will void the autoloader's warranty instantly.
- Contact our Tech Support.

Why does my autoloader stay at "System Bootup"?

- The reason the autoloader stays at system bootup forever is caused by improper shut down. To solve the problem, contact our Tech Support department. Even though this problem can be solved, all the hard drive information will be lost due to this failure.

How do I reset my autoloader back to default?

- See "Load Default" on page 35.

1. List of Error Code

Code	Short Description	Full Description
10	Arm did not return to top position	If error code 10 is shown, it represents that the vacuum picking arm did not return to the top position within 10 seconds after a command was sent out. The vacuum picking arm must return to the top position after each action. This indicates an obstruction or mechanical failure prevented the vacuum picking arm from completing the requested action.
11	Arm did not detect specified location in the allotted time	If error code 11 is shown, it represents that when the vacuum picking arm is instructed to pick up a disc, it has failed to detect anything (including the bottom of the bin) within 10 seconds. This would apply to inserting a disc in a drive and not detecting anything within 10 seconds if the Z Maneuver feature is disabled. This error indicates that an obstruction, missing component or mechanical failure has prevented the vacuum picking arm from detecting a disc, drive, etc to perform the assigned task.
12	Unable to move to the next input/output bin	If error code 12 is shown, it represents that the vacuum picking arm did not travel to its destination input/output bin from any other bin within 10 seconds. This error indicates that an obstruction or mechanical failure has prevented the vacuum picking arm from rotating to the assigned input/output bin.
13	Unable to move into the drop disc position	If error code 13 is shown, it represents that the vacuum picking arm did not reach the "drop" position within 4 seconds when placing a disc to output bin. The "drop" position represents the safe distance between the vacuum picking arm and the spindle where the disc can be placed securely onto the spindle. This error indicates that an obstruction, missing component or mechanical failure has prevented the vacuum picking arm from performing the assigned task.
14	Unable to perform the horizontal Z Maneuver from bin # 1 to the starting point	If error code 14 is shown, it represents that the vacuum picking arm did not reach the horizontal starting position for placing a disc into the appropriate drive starting from spindle bin #1 within 4 seconds during the insert process. (This error is only shown when the Z Maneuver is enabled).
15	Unable to perform the horizontal Z Maneuver from the starting point to the original position	If error code 15 is shown, it represents that the vacuum picking arm did not reach the drive position within 4 seconds from the Z position starting point. This takes place when the vacuum picking arm has descended to the appropriate drive location and should move horizontally to center the disc over the opened drive tray but fails to do so in the specified allotted time. (This error is only shown when the Z Maneuver is enabled).
16	Unable to perform vertical Z Maneuver while placing disc in drive tray	If error code 16 is shown, it represents that the vacuum picking arm did not descend and place the disc into the opened drive tray within 4 seconds after the vacuum picking arm has centered the disc above the opened drive tray. (this error is only shown when the Z Maneuver is enabled).
17	Unable to perform the horizontal Z Maneuver from the original position to the starting point	If error code 17 is shown, it represents that the vacuum picking arm did not return to starting horizontal position for the reverse Z Maneuver within 4 seconds to return the disc to the output bin. (This error is only shown when the Z Maneuver is enabled).

20	Input bin empty	If error code 20 is shown, it represents that all of the input bins are empty. This error commonly comes up every time the autoloader does not detect anymore blank media to load into the drives. If this error arises and you are finished, press the left arrow to end the copy process. If you are not finished, restack the blank media from the first input bin to the remaining bins as needed and push the right arrow key to continue the duplicating procedure.
21	Input bin missing	If error code 21 is shown, it represents that the input bin is missing. This error indicates that an obstruction, missing component or mechanical failure has prevented the vacuum picking arm from detecting the input bin to perform the assigned task.
30	Unable to locate drive tray for output of the disc	If error code 30 is shown, it represents that the vacuum picking arm did not detect an opened tray before reaching its lowest descending limit when attempting to pick up a finished disc from a specified drive tray.
40	Clear previous error	If error code 40 is shown, it represents that a new command was received while an error flag is still registered. In order to proceed, the previous error needs to be cleared by using "c" to remove the previous error flag.
60	Unable to locate drive tray for input of the disc	If error code 60 is shown, it represents that the vacuum picking arm did not detect an opened tray before reaching its lowest descending limit when attempting to place a blank disc into a specified drive tray.
70	Disc dropped during input procedure	If error code 70 is shown, it represents that a disc was picked from an input bin and the vacuum picking arm dropped the disc on the way to one of the drive trays.
71	Failure to pick up a disc from input bin	If error code 71 is shown, it represents that the vacuum picking arm failed to pick up a disc from an input bin after 3 continuous attempts.
80	Disc remaining on vacuum block not loaded on to the drive tray	If error code 80 is shown, it represents that a disc attempting to be placed on a drive tray remained attached to the vacuum block and was not properly dropped from the vacuum picking arm into the drive tray.
90	Disc dropped during output procedure	If error code 90 is shown, it represents that a disc was picked from a drive tray and the vacuum picking arm dropped the disc on the way to the appropriate output bin.
A0	Output bin full	If error code A0 is shown, it represents that the output bin is full. This commonly occurs if the input bin was filled with more discs while completed discs were deposited to the output bins increasing the total disc capacity beyond the maximum output capacity.
B0	Cannot detect disc in drive tray	If error code B0 is shown, it represents that the vacuum picking arm is attempting to remove a disc from a drive tray and cannot detect the disc. This commonly occurs when the disc was removed from the tray before the vacuum picking arm had an opportunity to pick it up.
C0 ~ C5	Disc misloaded in output bin #	If error code C0 ~ C5 is shown, it represents that a disc being returned to the output/ng was not properly dropped from the vacuum picking arm onto the output bin 0 ~ 5, respectively, where bin 0 indicates the position right in front of the drive housing.
FF	High static shock error	Too much static electricity builds up from the disc. This error occurs when the static electricity on the disc is too high. Either the facility produces too much static electricity or the current climate is conducive to high concentration of static electricity. This error is caused by the buildup of an electric static charge which shocks the robotic arm while loading a disc. If this error should occur, the user must completely reboot the system by turning the unit off at the power button. When the unit is turned on again, it should operate normally, but you will need to reprogram the job it was running.

2. Menu Tree

1. Copy <Partition> <Counter>
2. Test <Partition> <Counter>
3. Compare <Partition> <Counter>
4. Test+Copy <Partition> <Counter>
5. Copy+Compare <Partition> <Counter>
6. Select Burn Speed <HDD to CD | HDD to DVD>
7. Select Source <Hard Drive>
8. Master Mode <SM | MM>
9. Erase RW <Quick | Full>
10. Hard Drive Setup
 - 10.1 Select Partition
 - 10.2 Load Partition
 - 10.3 Rename Partition
 - 10.4 Delete Partition
 - 10.5 Partition Info
 - 10.6 Partition Size
 - 10.7 Format Hard Drive
11. Setup
 - 11.1 Language
 - 11.2 Read Error Skip
 - 11.3 CD Writing Mode
 - 11.4 Max Audio, VCD, and CDG Speed
 - 11.5 Buzzer
 - 11.6 Startup Menu
 - 11.7 Screen Saver
 - 11.8 Counter
 - 11.9 AUTOCOPY Enabled
 - 11.10 DVD+R Compatibility Mode
 - 11.11 Disable Drives
12. System Utilities
 - 12.1 Disc Info
 - 12.2 System Info
 - 12.3 Device Info
 - 12.4 Load Default
 - 12.5 Update Firmware
13. Loader Utilities
 - 13.1 Drive Alignment
 - 13.2 Spindle Alignment
 - 13.3 Disc Separator: <Separator Off | Single Vibration | double | triple>
 - 13.4 Z form Maneuver <On | Off>
 - 13.5 Alignment Protection
14. Manage Accounts
 - 14.1 View User
 - 14.2 Create User
 - 14.3 Edit User Info
 - 14.4 Delete User
 - 14.5 Password on Bootup
15. Shutdown
16. AUTOCOPY (Optional)